



L23 CHESHIRE P23 MONET TRIO P23 ENIGMA

FLUELESS GAS FIRE

INSTALLATION AND USER INSTRUCTIONS



All instructions must be handed to user for safekeeping

Revision B - 11/08

Country(s) of destination - GB/IE

Focal Point Fires plc, Christchurch, Dorset BH23 2BT

Tel: 01202 499330 Fax: 01202 499326

www.focalpointfires.co.uk

e-mail: sales@focalpointfires.co.uk





L23 Cheshire



P23 Monet trio



P23 Enigma silver glass

The products covered by this booklet are protected under patent GB2275331B.

Please note : Except where otherwise stated, all rights, including copyright in the text, images and layout of this booklet is owned by Focal Point Fires plc. You are not permitted to copy or adapt any of the content without the prior written permission of Focal Point Fires plc.

INSTALLATION INSTRUCTIONS

Preliminary Notes Before Installation

This appliance is a high efficiency, flueless, flame effect gas fire. It provides radiant and convected warmth both efficiently and safely utilising the latest type catalytic convertor burner technology.

The appliance incorporates a combustion monitoring system (Oxygen Depletion System). It must not be adjusted or put out of operation. If replaced then manufacturers original parts must be used.

The appliance is designed to fit various types of situations as listed in the Installation Requirements.

This appliance must be installed in accordance with the rules in force and only used in a sufficiently ventilated space. A minimum of 100cm² (15.5in²) purpose provided ventilation is required for this appliance. An openable window or louvre is also required. This appliance is factory set for operation on the gas type, and at the pressure stated on the appliance data plate.

The room size should be a minimum of 23m³ (812ft³) to allow adequate circulation of air and ensure the correct operation of the fire. This volume may include adjacent spaces but these spaces must not be separated by a door. In order to convert from cubic feet (ft³) to cubic metres (m³) divide the room volume (in ft³) by 35.3. This appliance is intended as a secondary source of heat only and should not be used in a room without some form of background heating present.

The appliance must not be installed in a bedroom, bathroom or any sleeping area. The appliance does not require a flue system of any type as the catalytic converter cleans the flue products to provide a complete combustion system, which is intrinsically safe.

The appliance must be installed by a competent person in accordance with Gas Safety (Installation and Use) Regulations 1998 or rules in force. It is strongly recommended that a CORGI registered engineer is used for this purpose, as they are the only persons approved by the HSE under the above regulations.

On initial lightup of a new appliance, the 'newness' will burn off within the first few hours of operation. During this period some smoke may be emitted from outlet grille, this should be no cause for concern. Accordingly, the room should be well ventilated with all windows and doors open during this period.

Read all these instructions before commencing installation.

<i>Section</i>	<i>Contents</i>	<i>Page No.</i>	<i>Section</i>	<i>Contents</i>	<i>Page No.</i>
1.0	Important Notes	1	8.0	Testing and Commissioning	6
2.0	Appliance Data	2	8.1	Operating the Appliance	6
3.0	Installation Requirements	2	8.2	Spark Failure	6
3.1	Room Sizing	2	8.3	Setting pressure	6
4.0	Site Requirements	2	8.4	Fitting the Decorative Frame	7
4.1	Ventilation	3	9.0	Briefing the customer	8
5.0	Unpacking the Appliance	4	10.0	Servicing	8
5.1	Component Checklist	4	10.1	Servicing the Burner Unit	8
6.0	Gas Supply Routes	4	10.2	Pilot Assembly	9
7.0	Fixing the Appliance	5	10.3	Catalyst	9
7.1	Checking the Burner	5	10.4	Testing for Firebox Leakage	9
			11.0	Troubleshooting Guide	10
			User Instructions		

1.0 IMPORTANT NOTES

This appliance is a catalytic flueless flame effect gas fire, providing radiant and convected warmth. It is designed to operate on Natural Gas following factory set adjustments, (see Data Plate on appliance for gas type and pressure).

It is the LAW that all gas appliances and fittings are installed by a competent person (such as a CORGI registered fitter) and in accordance with the Gas Safety (Installation and Use) Regulations 1998, the relevant British Standards for Installation, Codes of Practice and the Manufacturers' Instructions. The installation shall also be carried out in accordance with the following regulations:

The Building Regulations issued by the Department of the Environment, the Building Standards (Scotland) (Consolidation) Regulations issued by the Scottish Development Department.

Relevant British standards insofar as the relevant areas are not covered by these instructions.

Note: For Republic of Ireland, reference should be made to the relevant standards governing installation. (IS 813: 1996)

Failure to comply with these regulations could lead to prosecution and deem the warranty invalid.

This appliance must be installed in accordance with the rules in force and used only in a sufficiently ventilated space. A minimum of 100cm² (15.5 in²) purpose provided ventilation is required for this appliance, an openable window or louvre is also required. To reduce the possibility of draughts entering the room via the air vent, we recommend the use of "Black Hole" or "Vortex" type vents featuring internal baffles.

It should be noted that heaters create warm air currents. These currents move heat to wall surfaces next to the heater. Installing the heater next to vinyl or cloth wall coverings or operating the heater where impurities in the air (such as tobacco smoke) exist, may discolour walls.

Consult ALL instructions before installation and use of this appliance.

This appliance is free from any asbestos material.

2.0

APPLIANCE DATA

	L23 Models	P23 Models
Gas Group	G20 Natural Gas CAT I2H	G20 Natural Gas CAT I2H
Inlet Pressure	20 mbar (+/- 2.0mbar)	20 mbar (+/- 2.0mbar)
Max Energy Input	Gross 2.0 kW Net 1.8 kW	Gross 2.0 kW Net 1.8 kW
Max Gas Rate	0.20 m3/h	0.20 m3/h
Min Energy Input	Gross 1.3 kW Net 1.15 kW	Gross 1.0 kW Net 0.9 kW
Pilot Energy Input	Gross 166 W Net 150 W	Gross 166 W Net 150 W
Burner Pressure High	18.7 mbar. (+/-1.5 mbar). Hot 18.6 mbar. (+/-1.5 mbar). Cold	18.7 mbar. (+/-1.5 mbar). Hot 18.6 mbar. (+/-1.5 mbar). Cold
Low	7.4 mbar. (+/-0.75 mbar). Hot 7.3 mbar (+/-0.75 mbar). Cold	4.1 mbar. (+/-0.75 mbar). Hot 4.0 mbar (+/-0.75 mbar). Cold
Main burner flow restrictor	Stereo 1.03mm (1/4" BSP)	Stereo 1.03mm (1/4" BSP)
Oxypilot	SIT/Bray 9082	SIT/Bray 9082
Gas Valve	BM733/NGC6802	BM733/NGC6802
Gas Inlet Connection	8mm inlet restrictor elbow	8mm inlet restrictor elbow
Ignition	Piezo spark	Piezo spark
Spark Gap	4.0 mm (± 1.0mm)	4.0 mm (± 1.0mm)

Please see Data Badge affixed to appliance for current data.

This appliance is for use only with the gas type, and at the pressure stated on the appliance Data Badge.

3.0 INSTALLATION REQUIREMENTS

If the appliance is to be sited near a disused natural draught flue it is recommended that the old flue should be partially sealed off to prevent draughts, however some ventilation will be required to prevent condensation. The appliance is designed to be wall mounted. It is possible to install the appliance onto certain types of combustible materials - see section entitled 'Clearances to combustible materials'.

In the event that the fire is sited near a disused or unserviceable fireplace served by a natural draught flue, any existing under grate draught device should be sealed off to prevent loss of heat or creation of draughts. The passageway into the flue should be partially sealed to prevent excessive draughts, however some ventilation will be required in the old flue to prevent condensation and dampness. Advice should be sought from your local building control officer.

3.1 ROOM SIZING

All Models : The room size should be a minimum of 23m³ (e.g. 10'1" x 10'1" x 8') to allow adequate circulation of air and ensure the correct operation of the fire. This volume may include adjacent spaces but these spaces must not be separated by a door. To calculate a room size in cubic metres (m³) divide the room volume in cubic feet (ft³) by 35.3.

4.0 SITE REQUIREMENTS

This appliance is designed to be wall-hung. Do not recess any part of the appliance into the wall.

This Appliance may be installed in any room in a home except bedrooms and bathrooms.

Installation in living rooms is common, however other rooms such as kitchens, dining rooms and hallways are permitted, providing a suitable natural gas supply is available, and rooms sizing and ventilation requirements are strictly adhered to (see section 4.1).

The appliance is designed to be versatile, and as such will operate correctly when exposed to normal gentle draughts experienced within the home. It is not recommended, however that the appliance be installed in areas where it is likely to be exposed to persistent strong draughts, that may be generated by outside doors or windows, air vents etc. It is recommended that the appliance should not be installed within one metre of any air vent.

4.0 SITE REQUIREMENTS (continued)

Clearances to non-combustibles

Non combustible surfaces are defined as brick, metal, marble, concrete etc. and also a number of man-made materials impervious to flame. If in doubt refer to the material manufacturer for further information before proceeding with installation.

Clearances to the sides of the appliance are 100mm (4in). Clearance to the front of the appliance is 500mm (20in).

The back of the appliance may be installed directly onto a non-combustible wall, providing the area behind the appliance is flat and does not interfere with the various vent holes in the back panel of the appliance.

A non combustible shelf of any depth may be positioned above the appliance provided it is no closer than 400mm from the top of the appliance glass panel and the wall above the appliance is non combustible.

The appliance must not be positioned vertically within 60mm (2.4in) of a solid floor (i.e. wood or stone) or hearth. This dimension is measured vertically to the bottom of the appliance firebox.

Clearances to combustible materials

Combustible materials are defined as wood, fabrics, or other materials likely to combust if exposed to flame. Generally, any material, which is likely to discolour, melt or misshape when exposed to moderate heat, should be considered as a combustible material or surface.

Clearance to the sides of the appliance are 100mm (4in) but curtains, drapes and other fabrics are not permitted within a distance of 500mm (20in) of the appliance sides. No such materials are permitted directly above the appliance regardless of distance.

The minimum clearance to the ceiling above the appliance is 800mm (31.5in) measured from the top of the appliance inner glass panel.

Combustible materials should not be positioned directly in front of the appliance within a distance of one metre.

Under no circumstances should any electrical equipment e.g. plasma screen TV sets etc. be positioned on the wall above the appliance. The appliance is designed to be wall mounted alone and not in conjunction with any type of combustible fire surround. No combustible shelves should be positioned on the wall above the appliance. It should be established that any mirrors or picture frames etc. to be positioned on the wall above the appliance are able to withstand prolonged exposure to moderate heat and moisture before proceeding with their installation.

The back of the appliance may be installed directly onto a combustible wall, providing it is relatively flat and does not interfere with the various vent holes in the back panel of the appliance. The wall must be structurally sound and constructed from a material capable of withstanding moderate heat. Finished plaster, conventional wall paper and dry-lined plasterboard are examples of suitable materials. Materials such as flock, blown vinyl and embossed paper which are sensitive to even small amounts of heat should be avoided as scorching and or discolouration may occur over time.

If the appliance is to be mounted on a dry lined wall or a timber framed construction wall then the integrity and ability of the wall to carry the weight of the appliance must be confirmed. It is important in these circumstances that any vapour control barrier is not damaged, and that any structural members of the house frame are not damaged.

The appliance must not be positioned vertically within 100 mm (4in) of a carpeted floor, rugs or fabric materials of any kind. This dimension is measured vertically to the bottom of the appliance firebox.

4.1 VENTILATION

A minimum of 100 cm² purpose provided ventilation is required for this appliance. This may be achieved either with one vent 100 cm² at a high or low position in the room, or split ventilation i.e. 50cm² be installed at high level and 50cm² be installed at low level within the room. An openable window or equivalent is also required. The requirements of other flued appliance operating in the same room or space must be taken into consideration when assessing ventilation.

4.1 VENTILATION (continued)

Any ventilation fitted must comply with BS 5871 part 4 and BS 5440 part 2. Ventilation fitted under, or within immediate vicinity of the appliance must not be used as it may adversely effect performance of the ODS system. The appliance **MUST NOT** be installed in a bedroom, bathroom or any sleeping area. For Republic of Ireland, see relevant rules in force. The appliance should not be installed within one metre of any air vent.

5.0 UNPACKING THE APPLIANCE

Remove the outer packaging, remove any instructions or fixing kits.

Read ALL these instructions before continuing to unpack or install this appliance.

Lift off the remaining packaging components and remove the contents of the box.

Check that the components supplied correlate with the component checklist. Please dispose of all the packaging materials at your local recycling centre.

5.1 COMPONENT CHECKLIST

QUANTITY	DESCRIPTION
1	Firebox and burner assembly
1	Set of manufacturers instructions
1	Decorative black glass facia assembly (L23 Cheshire models)
3	Decorative metal facia panel in a variety of colours (P23 Monet trio models)
1	Decorative silver glass facia panel (P23 Enigma models)
4	Decorative metal corner columns (P23 Enigma models)
1	Screw and wall plug pack
1	Rubber grommet
1	Fitting template

6.0 GAS SUPPLY ROUTES

There are four possible entry points for the gas supply pipework to enter the appliance firebox. These entry points are 'knock out' type holes. Non-concealed gas connections may be made using the entry points at either end of the firebox or the one in the bottom of the firebox. A concealed gas connection may be made using the knock out hole in the centre back of the firebox. Select the most appropriate entry point and knock out the relevant hole

No more than 1.5m of 8mm diameter pipe must be used to avoid unnecessary pressure drops.

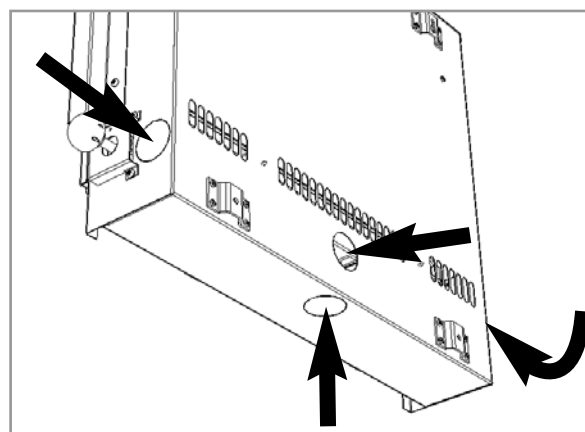

If a concealed gas connection is to be made, the supply pipe should always be sleeved through walls and floors using the shortest possible route. For concealed supply pipe routing, pipes must (where possible) be vertical and providing there is sufficient wall thickness available, they should be placed in pipe chases. Horizontal pipe runs should be avoided. Prior to chasing a solid wall, an inspection should be made to note the proximity of any cables/sockets outlets which may already be buried.

Pipes must be secured using suitable clips and protected against corrosion. Ideally factory finished protected pipework and fittings should be used. Joints should be kept to a minimum and compression fittings must not be used. The pipework installation must be tested for soundness before any protection is applied and/or the pipework and fittings are buried.

7.0 FIXING THE APPLIANCE

After having selected the final mounting position of the appliance, taking into account the site requirements as specified in section 4 of these instructions, the integrity of the wall, and the feasibility of the proposed supply pipe routing, the firebox of appliance may be secured to the wall. A fitting template is supplied to assist with this.

- For L23 Cheshire models : Mark the positions shown as “Gas model L23G” on the wall.
- For P23 Monet trio and P23 Enigma models : Mark the positions shown as “Gas model P23G” on the wall.

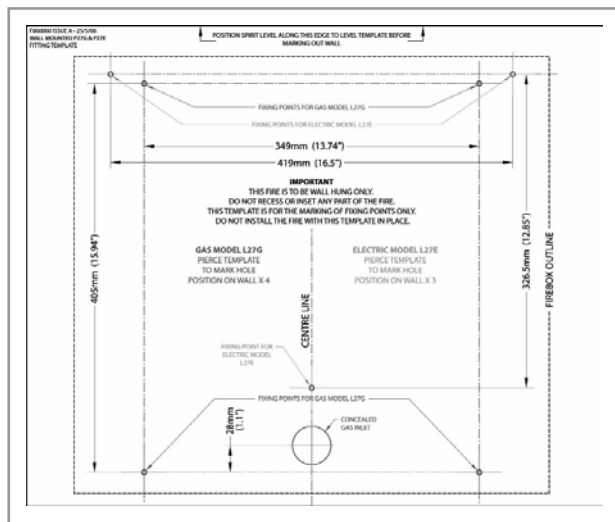

If the appliance is to be mounted on the inner leaf of a conventional cavity wall, or a solid wall, drill four holes to a depth of 42mm using a 8mm masonry bit. Insert the wallplugs provided.

If the appliance is to be mounted on a dry lined wall or a timber framed construction wall then special cavity screw fixings will be required which are not supplied with this product. These should be constructed from metal and not plastic.

If a concealed gas connection is to be made ensure the gas supply pipe is in it's final position and can enter the appliance in the correct position when the appliance is hung on the wall.

Insert the wall fixing screws into the top wall plugs, taking care to leave the screws protruding approximately 5mm from the wall. Now hang the appliance onto these screws through the two key-hole shaped holes in the back panel of the appliance.



Insert the lower fixing screws into the lower wall plugs through the corresponding fixing holes in the lower part of the back panel. Do not tighten fully.

Before tightening the wall mounting screws fully, at this stage it is recommended to check the horizontal alignment of the appliance with a spirit level, as small adjustments can still be made if necessary. When this has been checked, tighten all four fixing screws fully.

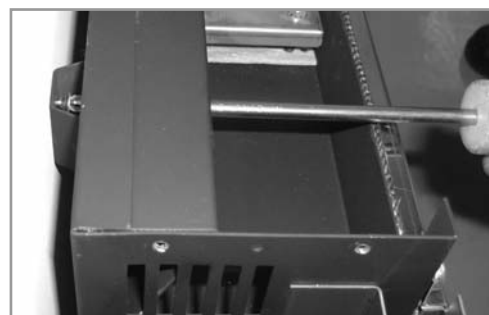

To access the upper fixing screws insert a screwdriver either through the round holes in the front of the outlet grille, or alternatively for easier access the outlet grille may be removed and the fixing screws accessed more directly through the holes in the deflector baffle as shown above.

7.1 CHECKING THE BURNER

There are no imitation fuel bed components to install. The appliance features a ribbon burner which is designed to produce a continuous band of flame over it's length.

The burner should be visually inspected to ensure it is free from any foreign matter.

If it is necessary to clean or dust off the burner then the glass door should be removed by removal of the four retaining screws. Re-fit the glass door after cleaning or inspection, ensuring a good seal.

8.0 TESTING AND COMMISSIONING

Turn on and test the gas supply up to the fire for any leaks, in accordance with the current edition of BS6891.

8.1 OPERATING THE APPLIANCE

The pilot is visible behind the left hand side of the burner.

The control knob is located on the lower right hand side of the outer case. It is of a spherical design and is marked as shown in the diagram to the right;

Push in and turn the control knob to the SPARK position, and hold there for a few seconds. Continue turning anti-clockwise through the spark click to the PILOT light position, ensuring the pilot has lit. If not, return the knob clockwise, and repeat.

When the pilot lights after the spark, keep the knob depressed for approximately ten seconds. Now release the knob and the pilot should stay alight. If the pilot is extinguished during use, wait three minutes before repeating the ignition procedure.

To achieve the HIGH setting, push the control knob in slightly and continue turning anti-clockwise to the high position. The main burner should light after a few seconds. To decrease the setting to LOW, turn the control knob clockwise to the low setting.

To turn to the PILOT position from the HIGH or LOW positions, press the control knob in, and return to the pilot position and release. To turn the fire OFF, keep the knob pressed in, return to the off position and release.

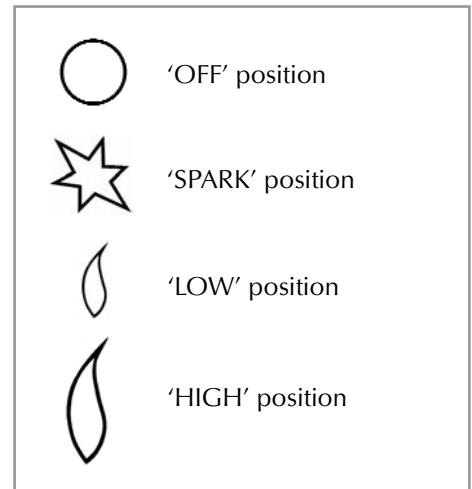

8.2 SPARK FAILURE

The gap between the spark electrode and the pilot should be 3 - 5mm to produce a good spark. There should be no need to adjust this. If under any circumstances the piezo electric spark fails, the pilot cannot be lit manually.

8.3 SETTING PRESSURE

The pressure test point is located on the left hand side of the appliance, on the main burner pipe, next to the brass restrictor/connector. Release the setting pressure test point screw, and attach a U gauge. Light the fire on the HIGH setting.

To commission the appliance, the burner pressure must be in accordance with the figures stated in the data section of these instructions.

The fire is factory set to achieve these pressures and any significant variation could indicate a supply problem. If the pressure is too high, the gas supply meter may be set incorrectly. This should be checked with the fire running and if necessary reset by the gas supplier.

If the burner pressure is too low, then check the inlet pressure with the appliance running. If this is less than approximately 20mbar it will need to be reset by the gas supplier. If the setting pressure is too low, but the meter pressure is acceptable, then a problem in the supply pipework is to be suspected.

This will be dirt and debris, kinked or inadequate size pipes, restriction in a fitting, shut off elbow not fully open or solder flashing across a joint. Identify the cause of the restriction and rectify. Switch the fire off, disconnect the U gauge and refit the test nipple screw. Light the fire and check for gas soundness.

In the event that the burner pressure is not in accordance with the figures stated in the data section of these instructions, the appliance must not be commissioned, and the manufacturer should be contacted for guidance.

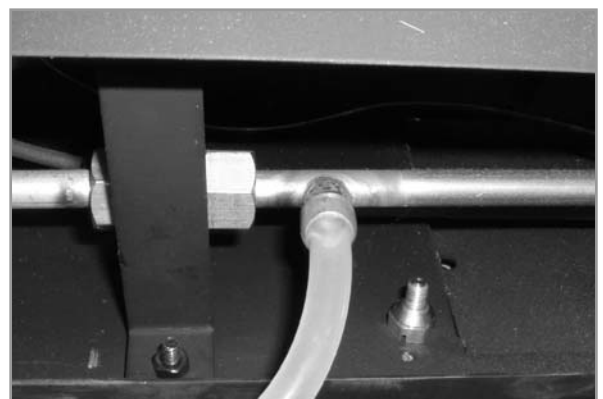

8.4 FITTING THE DECORATIVE FRAME ASSEMBLY

P23 Monet Trio models :

The appliance is supplied with a selection of differently coloured decorative frames. Remove the chosen decorative frame assembly from any protective packaging, and remove any protective film that may be present on the frame.

The frame is hung onto the firebox via the two upper hanging brackets and then secured to the firebox via the two lower knurled fixing bolts, which are inserted through the holes in the lower frame mounting brackets after the frame is in position. See diagrams to the right and below.

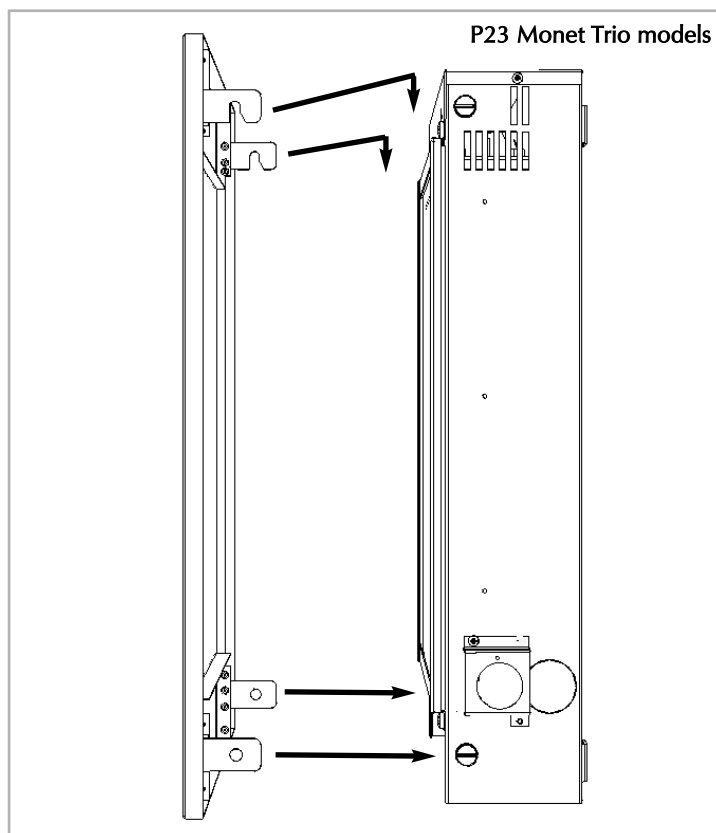
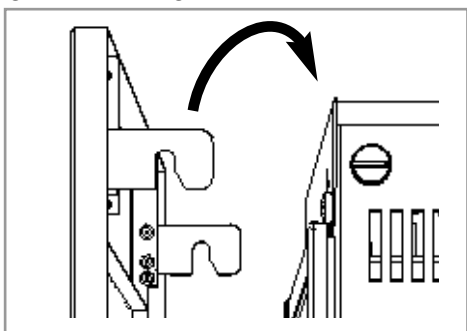

L23 Chesire models and P23 Enigma models:

Remove the glass facia panel from any protective packaging. The glass facia panel is supported by four M6 screws which protrude from the front of the outer casing.

Ensure each screw is unscrewed approximately one turn from the fully screwed in position in order to create a 2mm gap (shown).

Simply hang the facia panel onto the outer casing ensuring that the corresponding key-hole shaped holes engage the screwheads fully.

P23 Enigma models:

To fit the decorative corner columns, ensure the main glass facia is mounted in position. Remove any transit tape and unscrew the front clamping disc and remove.

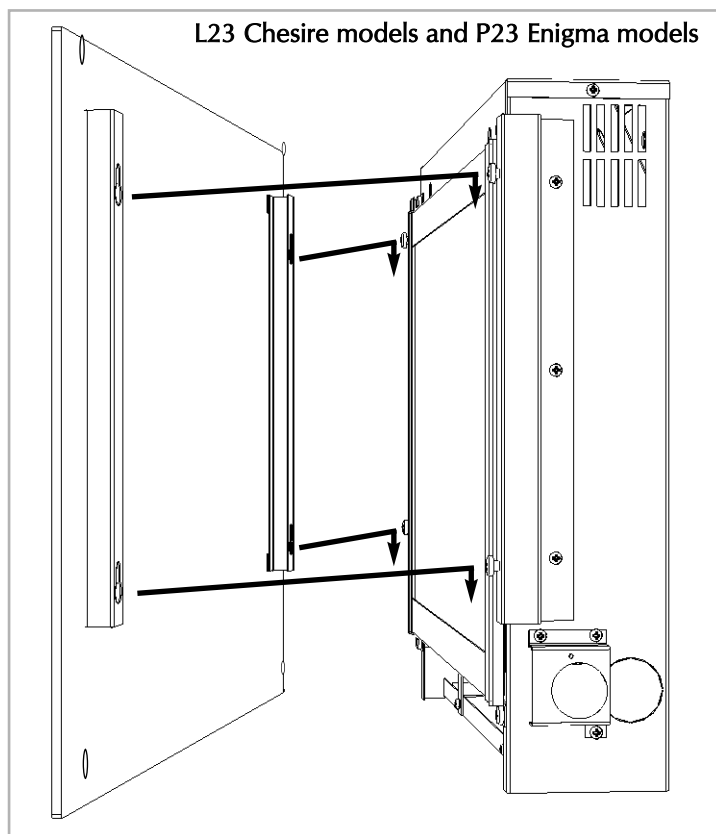
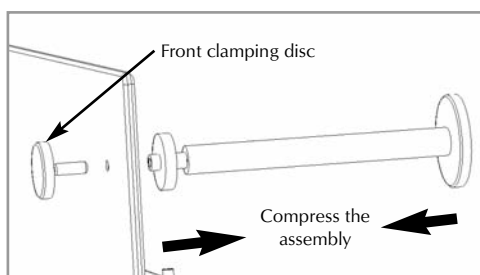

Compress the column assembly and position behind the glass panel, lining up with the appropriate hole. Release the assembly when in position and secure in place by refitting the front clamping disc.

9.0 BRIEFING THE CUSTOMER

All instructions must be handed to the user for safekeeping. Show the customer how to light and control the fire. After commissioning the appliance, the customer should be instructed on the safe use of the appliance and the need for regular servicing. Frequency of service depends on usage, but **MUST** be carried out at least once annually.

Advise that cleaning of the fire may be achieved when the fire is cold using a damp cloth and mild detergent on most surfaces. Advise that the fire will emit a "newness" smell for a time after initial commissioning and that extra ventilation may be needed during this time. Recommend that a guard be used for the protection of the young, pets, the elderly and the infirm

10.0 SERVICING

Isolate the fire from the gas supply. Ensure that the fire is fully cold before attempting service. A suggested procedure for servicing is detailed below.

1. Lay out the dustsheet and tools.
2. Remove the decorative frame/glass fascia assembly. Removal is reverse of section 8.4.
3. Remove the glass door assembly (4 screws) and clean carefully.
4. Inspect the burner and the catalyst and clean if necessary with a soft brush.
5. Disconnect the gas supply.
6. Detach the burner front cover plate by removal of the four retaining screws. Undo the four screws retaining the burner support brackets to the base and rear of the firebox. Remove the control knob and spindle assembly from the valve by removal of the spindle retaining clip.
7. Remove the burner unit, strip off the burner pipes and clean thoroughly.
8. Clean the in-line restrictor, pilot assembly and the burner tube. Do not attempt to remove the pilot injector as this can cause damage.
9. Re-assemble components.
10. Turn on the gas supply and leak test. Check pilot and burner for good ignition.
11. Refit the glass door assembly, ensuring correct orientation and a good seal.
12. Refit the decorative fascia/frame assembly as detailed in section 8.4.
13. Check the purpose provided ventilation is un-obstructed.
14. Light the fire and test setting pressures.
15. Check safe operation of the appliance.

For specific servicing instructions, see relevant sections.

10.1 SERVICING THE BURNER UNIT AND GAS ASSEMBLY

Firstly, remove the decorative glass fascia assembly as described in section 8.4. Remove the inner glass panel, and disconnect the gas connection inside appliance. The gas connections to the gas valve can now be released. Detach the burner front cover plate by removal of the four retaining screws. Undo the four screws retaining the burner support brackets to the base and rear of the firebox, and remove the control knob and spindle assembly by removal of the spindle retaining clip. The burner may now be removed.

Remove the pilot and main burner pipes and blow through to dislodge any debris. Now remove the restrictor elbow and blow through to make sure it is entirely clear.

Unclip the pilot lint gauze and clean with a soft brush. Clean the exterior of the pilot assembly with a soft brush and blow through the flame ports on the pilot head. Check the aeration holes are free from lint or dirt. The pilot assembly can be removed if required by disconnecting the electrode HT lead, gas pipe and unscrewing the mounting screws and lifting away.

The pilot assembly is a non-serviceable item and should not be taken apart. Aeration holes must be absolutely clear internally for proper operation. **NEVER MODIFY OR BEND THE THERMOCOUPLE TO MAKE THE PILOT STAY ALIGHT.** Modifications are dangerous and can have serious unseen effects on safety. If the pilot will not stay lit there is a problem with dirt, the gas supply to it, or the thermocouple needs replacement.

The gas valve is a non-serviceable item. If this needs replacement, remove M4 securing screw holding the valve in place, remove all pipe unions, electrode lead, thermocouple lead and then the complete valve. Replacement must be original manufacturers parts. Re-assembly is the reverse of removal. Ensure setting pressures are as stated in Section 2; Appliance Data.

10.2 PILOT ASSEMBLY

Clean the pilot assembly with a soft brush and blow through. Check the aeration holes are free of any dirt or lint. Clean thoroughly internally, the connection can be removed from the base of the pilot unit using two spanners to make cleaning easier. Do not damage or try to dismantle the pilot injector.

The unit is factory set and the only check necessary is to ensure the spark gap is correct. See specifications for gas setting.

NEVER MODIFY OR BEND THE THERMOCOUPLE TO MAKE THE PILOT STAY ALIGHT. If the pilot will not stay lit there is a problem with dirt, the gas supply, or the thermocouple needs replacement. Modifications are dangerous and can have a serious unseen effect on safety and therefore **MUST** not be done. Replacements must be original manufacturers parts. Re-assemble in the reverse of removal. Ensure setting pressures are as stated in Section 2; Appliance Data.

10.3 CATALYST

It is recommended that the catalysts are inspected for signs of damage and dirt during routine servicing procedures. The expected life of the catalysts is in excess of 11,000 hours (10 years of normal use). After this time the catalysts should be replaced.

If there are any deposits of dirt or soot on the catalyst they should be cleaned with a soft brush and a vacuum cleaner. If removed for cleaning ensure the seals are in good condition before replacing the catalyst. New seals will usually be required. The performance of the catalysts may be checked using a combustion gas analyser as follows. Any analyser used should conform to EN 50379-3.

Ignite the fire as per the operating instructions, and run at maximum setting for 15 minutes. Position gas sample probe directly over the catalysts via the outlet grille, on top of the appliance. Record the carbon dioxide (CO₂) concentration and then the carbon monoxide (CO) concentration as displayed by the analyser - also noting the units in which the values are expressed.

Most analysers display carbon dioxide (CO₂) concentrations in percentage (%) terms and carbon monoxide concentration in parts per million (ppm) terms.

In order to calculate the combustion ratio for the appliance (CO/CO₂) it is first necessary to express both gas concentrations in terms of percentage. To convert from parts per million (ppm) to a percentage (%) divide the ppm figure by 10,000. Examples : 35ppm = 0.0035%, 15ppm = 0.0015%, 5ppm = 0.0005%.

Now divide the concentration of carbon monoxide (CO) expressed in percent by the concentration of carbon dioxide (CO₂) to obtain the appliance combustion ratio.

$$\frac{\text{CO (\%)}}{\text{CO}_2 (\%)} = \text{ratio}$$

The combustion ratio of the gasses emitted by the catalytic convertor should not exceed 0.0015.

If replacing, firstly, remove the decorative frame/glass facia as described in section 8.4. The catalysts are located on the top of the internal firebox and can be removed by unscrewing the retaining nuts securing the clamping plates. Remove the catalysts their seals and discard. Refit the new catalysts and seals in reverse order, ensure the catalysts and the glass door have good seals.

10.4 TESTING FOR FIREBOX LEAKAGE

Appliances that are several years old or have been extensively dismantled should be checked for soundness. It is important that all the products of combustion pass through the catalytic converter at the top of the firebox before leaving the appliance.

The firebox is heated by lighting for a few minutes to provide a flow through the firebox. The burner is then shut off and a smoke pellet or match introduced at the base of the fire underneath the burner tray. Large quantities of smoke will emerge from the top of the appliance, but none should emerge from the joints or gasket faces, especially around the door.

It is important to note that the appliance can never be expected to be 100% smoke tight and small quantities of smoke may be seen in corners of joints and gasket faces etc without affecting safety when the fire is in operation.

11.0 TROUBLESHOOTING GUIDE

Fire sparks but pilot does not light

No gas to fire, check isolators are open.
Pipe work blockage, clean out.
Air not fully purged, re purge supply or wait longer.
Spark earthing to metal work, reset gap correctly.
Blocked pilot, clean out internally.

Pilot lights but then goes out

Severe restriction in gas supply: clear obstruction.
Faulty thermocouple, replace pilot unit.
Blocked pilot, clean out.
Blocked lint gauze, clean.
Hold control knob in for longer.
Check control knob does not foul indicator plate.
If the pilot will not stay lit there is a problem with dirt, the gas supply, or the thermocouple needs replacement. Modifications are dangerous and can have a serious unseen effect on safety. NEVER MODIFY OR BEND THE THERMOCOUPLE TO MAKE THE PILOT STAY ALIGHT.

Fire does not spark at pilot

HT lead detached, refit.
Check the spark gap (see section 8.2).
Faulty piezo unit, replace.
Debris shorting out electrode, clean.
Spark shorting to metalwork under tray, realign HT lead.

Fire runs for a time and then cuts off

Loose or faulty thermocouple, rectify.
Blocked pilot, clean out.
Dirt or lint in pilot aeration hole or on the lint gauze, clean thoroughly.
If the pilot will not stay lit there is a problem with dirt, the gas supply, or the thermocouple needs replacement. Modifications are dangerous and can have a serious unseen effect on safety. NEVER MODIFY OR BEND THE THERMOCOUPLE TO MAKE THE PILOT STAY ALIGHT.

Pilot flame shrinks when fire is on high

Poor gas flow to fire, check pressure with fire on high.
If pressure is low, remove any restriction in pipework or valve.
Check all isolators are adequately sized and fully open.
Check meter pressure is adequate.
If the pilot will not stay lit there is a problem with dirt, the gas supply, or the thermocouple needs replacement. Modifications are dangerous and can have a serious unseen effect on safety. NEVER MODIFY OR BEND THE THERMOCOUPLE TO MAKE THE PILOT STAY ALIGHT.

Fire smells when first lit or in use

Newness smell from brand new appliance.
Leakage occurring. Carry out leakage test and rectify any problems.
Combustible materials used in incorrect positions.

USER INSTRUCTIONS

<i>Section</i>	<i>Content</i>	<i>Page No</i>
1.0	Important Notes	1
2.0	Clearances to Combustibles	2
3.0	Ventilation & Room Size	2
4.0	Operating Instructions	3
5.0	Combustion Monitoring System	3
6.0	Cleaning	3
7.0	Servicing	3
8.0	List of Replacement Parts	3

1.0 IMPORTANT NOTES

The installation and Servicing of this fire MUST only be carried out by a competent person (such as a CORGI registered fitter) in accordance with the Gas Safety (Installation and Use) Regulations 1998, the relevant British Standards, Codes of Practice, the Building Regulations and the manufacturer's instructions.

Failure to comply with the above recommendations could lead to prosecution and invalidate the appliance warranty.

Always keep a note of the installer's name and address, CORGI registration number, the original purchase receipt and the date of installation for future reference. Failure to produce these documents may invalidate the warranty.

The appliance should be serviced regularly to ensure continued safe operation. See the servicing section for further reference.

Parts of this appliance become naturally hot during use. It is recommended that a suitable fireguard conforming to BS 8423 : 2002 is used, especially where young children, pets, the elderly or infirm are concerned.

The manufacturer of this appliance considers all surfaces as working surfaces with the exception of the control knob and indicator bracket.

Combustible items, such as flooring and furniture and soft wall coverings (such as blown vinyl or embossed paper), low temperature surrounds etc may discolour if fitted too close to the fire. See relevant section for further details on clearances to combustibles. No combustible materials or flooring should protrude onto the hearth (if fitted).

This appliance incorporates a combustion monitoring system (ODS).

DO NOT burn any foreign material on this fire. Under no circumstances shall the appliance be used if the glass front door or panel has been removed, damaged or is open.

DO NOT place any objects on top of the appliance, or cover the outlet grille in any way. DO NOT operate the appliance with any parts removed or missing.

The integral catalysts should be checked by the installer upon servicing to ensure there are no defects or obstructions that may prevent the satisfactory flow of combustion products.

The expected life of the catalyst is in excess of 11,000 hours (10 years of normal use). After this time the catalyst should be replaced.

This appliance is only suitable for the gas type for which it is supplied.

It should be noted that heaters create warm air currents. These currents move heat to wall surfaces next to the heater. Installing the heater next to vinyl or cloth wall coverings or operating the heater where impurities in the air (such as tobacco smoke) exist, may discolour walls.

WARNING: Due to the nature of this product the area around the top of the appliance (i.e. the grille) gets very hot. Care should be taken when operating the appliance.

2.0 CLEARANCES TO COMBUSTIBLES

Clearances to combustible materials

Combustible materials are defined as wood, fabrics, or other materials likely to combust if exposed to flame. Generally, any material, which is likely to discolour, melt or misshape when exposed to moderate heat, should be considered as a combustible material or surface.

Clearance to the sides of the appliance are 100mm(4in) but curtains, drapes and other fabrics are not permitted within a distance of 500mm(20in) of the appliance sides. No such materials are permitted directly above the appliance regardless of distance.

The minimum clearance to the ceiling above the appliance is 800mm measured from the top of the appliance glass panel.

Combustible materials should not be positioned directly in front of the appliance within a distance of one metre.

Under no circumstances should any electrical equipment e.g. plasma screen TV sets etc. be positioned on the wall above the appliance. The appliance is designed to be wall mounted alone and not in conjunction with any type of combustible fire surround. No combustible shelves should be positioned on the wall above the appliance. It should be established that any mirrors or picture frames etc. to be positioned on the wall above the appliance are able to withstand prolonged moderate heat before proceeding with their installation.

The back of the appliance may be installed directly onto a combustible wall, providing it is relatively flat and does not interfere with the various vent holes in the back panel of the appliance. The wall must be structurally sound and constructed from a material capable of withstanding moderate heat. Finished plaster, conventional wall paper and dry-lined plasterboard are examples of suitable materials. Materials such as flock, blown vinyl and embossed paper which are sensitive to even small amounts of heat should be avoided as scorching and or discolouration may occur over time.

The appliance must not be positioned vertically within 100 mm of a carpeted floor, rugs or fabric materials of any kind. This dimension is measured vertically to the bottom of the appliance firebox.

Clearances to non-combustibles

Non combustible surfaces are defined as brick, metal, marble, concrete etc. and also a number of man-made materials impervious to flame. If in doubt refer to the material manufacturer for further information before proceeding with installation.

Clearances to the sides of the appliance are 100mm (4in). Clearance to the front of the appliance is 500mm (20in).

The back of the appliance may be installed directly onto a non-combustible wall, providing it is relatively flat and does not interfere with the various vent holes in the back panel of the appliance.

A non combustible shelf of any depth may be positioned above the appliance provided it is no closer than 400mm from the top of the appliance glass panel and the wall above the appliance is non combustible.

The appliance must not be positioned vertically within 60mm of a solid floor (i.e. wood or stone) or hearth. This dimension is measured vertically to the bottom of the appliance firebox.

3.0 VENTILATION AND ROOM SIZE

Purpose provided ventilation of 100cm² is required for this appliance. An openable window or equivalent is also required. The appliance should not be installed within 500mm of any air vent.

Any ventilation fitted must comply with BS 5871 part 4 and BS 5440 part 2. Ventilation fitted under, or within immediate vicinity of the appliance must not be used as it may adversely effect performance of the combustion monitoring system (ODS) system.

The requirements of other appliances operating in the space or room must be taken into consideration when assessing ventilation requirements, this will have been carried out by your CORGI registered installer.

A supply of fresh air into the room is advisable to maintain temperatures within limits. The appliance **MUST NOT** be installed in a bedroom or bathroom. For Republic of Ireland, see relevant rules in force.

3.0 VENTILATION AND ROOM SIZE (continued)

The room size should be a minimum of 23m³ (e.g. 10'1" x 10'1" x 8') to allow adequate circulation of air and ensure the correct operation of the fire. This volume may include adjacent spaces but these spaces must not be separated by a door. To calculate a room size in cubic metres (m³) divide the room volume in cubic feet (ft³) by 35.3. This appliance is intended as a secondary source of heat only and should not be used in a room without some form of background heating present.

4.0 OPERATING INSTRUCTIONS

The pilot is visible behind the left hand side of the burner.
The control knob is located on the lower right hand side of the outer case. It is of a spherical design and is marked as shown in the diagram to the right.

Push in and turn the control knob to the SPARK position, and hold there for a few seconds. Continue turning anti-clockwise through the spark click to the PILOT light position, ensuring the pilot has lit. If not, return the knob clockwise, and repeat.

When the pilot lights after the spark, keep the knob depressed for approximately ten seconds. Now release the knob and the pilot should stay alight. If the pilot is extinguished during use, wait three minutes before repeating the ignition procedure.

To achieve the HIGH setting, push the control knob in slightly and continue turning anti-clockwise to the high position. The main burner should light after a few seconds. To decrease the setting to LOW, turn the control knob clockwise to the low setting.

To turn to the PILOT position from the HIGH or LOW positions, press the control knob in, and return to the pilot position and release. To turn the fire OFF, keep the knob pressed in, return to the off position and release.

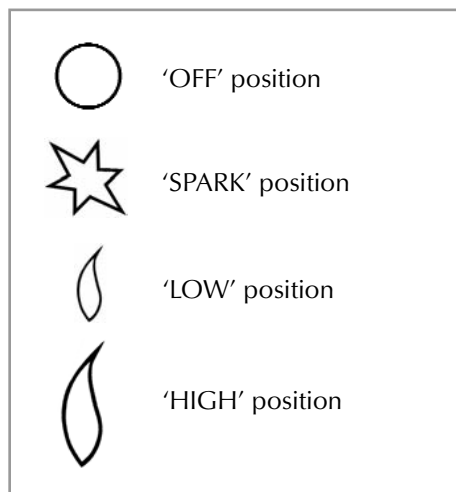

5.0 COMBUSTION MONITORING SYSTEM

This fire is fitted with a combustion monitoring safety device (ODS). If the appliance shuts down during use for no apparent reason then several reasons may be suspected. If a door or window has been opened creating a draught, then pilot disturbance could be the problem and removal of the draught should resolve this. The appliance can then be re-lit in accordance with the previous section.

If pilot disturbance is not the cause, then the ODS safety system may be in operation. Switch the appliance OFF, call in your installer to check the appliance and ventilation. Remedial work must be carried out as required. DO NOT allow the appliance to be used until the appliance and installation is passed as safe. If the pilot continues to be extinguished, you must call your installer to check the operation of the complete appliance.

6.0 CLEANING

Before carrying out any of the following operations, ensure that the appliance is OFF and completely cold.
INNER GLASS PANEL - This can be cleaned with a suitable glass cleaner, or proprietary ceramic hob cleaner. Test on a small area first.

GLASS FACIA PANEL - This should only be cleaned using a suitable glass cleaner. Test on a small area first.

PAINTED AREAS - These can be cleaned using a dry cloth.

7.0 SERVICING

The appliance should be checked on an annual basis to ensure it is working safely. The frequency of service will depend on usage, but MUST be carried out at least once annually. Servicing must be carried out by a competent person, such as a CORGI registered installer. The Installation instructions carry full servicing details for the use of the installer.

8.0 LIST OF SPARE PARTS

<i>PART NO.</i>	<i>ITEM</i>	<i>PART NO.</i>	<i>ITEM</i>
F960002	Glass door assembly	F730023	Pilot assembly
F730076	Gas valve	TRAY055	Burner tray
F780081	Catalyst	F940136	Seal kit for Catalyst